

Gootelementen ter plaatse in verstek te slijpen (45°).
Caniveaux à couper en onglet sur site (45°).

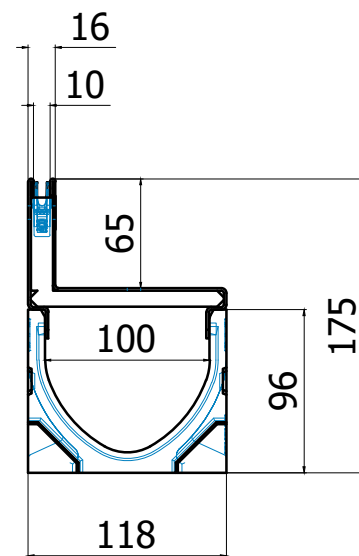

Bestaande uit / Composé de			
Type	Lengte / Longueur (mm)	Aantal / Quantité	Art.
Opzetstuk / rehausse	850	1	413040
Hoek / angle	150 x 150	1	446071
Goot / caniveau	1000	1	38500

Name		Date	 ACO Passavant NV/SA Preenakker 6 B - 1785 Merchtem Tel.: 052/38.17.70 Fax.: 052/38.17.71 info@aco.be www.aco.be
By	KV	25/01/2023	
Dimensions		mm	ACO House & Garden Euroline 100 Discre(e)t 65 Inox lange hoek - angle intérieur - 1m - B 125 kN
Drawing 446724.SET			
<i>Technische veranderingen voorbehouden - Sous réserve de changements techniques</i>			
Projection ISO-E	The reproduction, distribution and utilization of this document as well as the communication of its contents to others without express authorization is prohibited. Offenders will be held liable for the payment of damages. All rights reserved in the event of the grant of a patent, utility model or design. Observe copyright by ISO 16016		